



FUSION

FLUID EQUIPMENT

Agitation Without Aggravation

Fusion Fluid Equipment, LLC is a rapidly growing designer, manufacturer, and supplier of mixers, mixing accessories, and complete agitation systems for various processes for use in Industrial, Chemical, and Pharmaceutical mixing applications.

Whether you require standard or custom equipment, our use of modern design and manufacturing techniques allows us to confidently handle your projects ranging from simple to complex.

When you choose to partner with Fusion, you'll experience shorter lead times and superior service from our willing and knowledgeable staff that's available to you from start to finish.

Your time is valuable; spend it wisely! Let Fusion provide you with quality mixing equipment without the hassle *Agitation Without Aggravation.*

Visit Fusion's website for even more helpful info and tools!

www.fusionfluid.com

- The *Application Guides* will help direct you toward the mixers that will suit your needs.
- You'll find descriptions and mixing data for our impellers on the *Impeller Pages*.
- Our *Knowledge Center* offers valuable reference material regarding the Fundamentals of Mixing, O&M Manuals, and several FREE *Mixing Calculators*.

Subscribe to Fusion's YouTube channel.



CAPABILITIES:

3D Modeling
CNC Machining
Laser Cutting
Water-jet Cutting
Mechanical Forming
MIG & TIG Welding
Electropolishing
Polishing
Passivation
Coatings





Fusion offers quality, American-made equipment to its valued customers. We are proud to say, "Made in the U.S.A.!"



LOOKING FOR STATIC MIXERS?



- **D-Shape, Helical, and X-Grid elements**
- **Wide range of pipe diameters**
- **2 to 24 element range**
- **Stainless steel or composite materials**
- **ANSI flange, TC, or NPT connections**
- **Sanitary fittings and finishes available**



Order online at www.volcrest.com

info@volcrest.com (877) 812-7573 Volcrest is a TM and division of Fusion Fluid Equipment LLC.



















CONTENTS

Introduction	1
Equipment Overview	3
Options Overview	4
Pro Series Mixers	5
Pro Series Stainless Mixers	6
Axiom Mixers	7
Cirrus Mixers	8
Flow Series Mixers	9
Drum Series Mixers	11
Tote Series Mixers	12
Lift Stands	13
Turnkey Systems	15
Lab Mixers & Fusion Mod	17
Custom Mixers	18
Impellers	19
Custom Fabrication	20
Reference Data Mixer Mounting	21
Data Form	22









Equipment Overview

Product Guidelines

Equipment Overview							
Mixer Series	Direct Drive	Gear Drive	Batch Size	Max Shaft Length	Open or Closed Tank	Entry Point	Notes:
 <p>Pro Series</p>	1/4 - 5HP 1150 - 1750 RPM	1/4 - 5HP 175 - 350 RPM	5 to 3,000 gallons	120" FMB	Open or Closed	 Top Entry	Portable and Fixed Mounts
 <p>Pro Stainless Series</p>	1/4 - 5HP 1150 - 1750 RPM	1/4 - 2HP 175 - 350 RPM	5 to 3,000 gallons	120" FMB	Open or Closed	 Top Entry	Portable and Fixed Mounts All Stainless Steel
 <p>Axiom Mixer</p>	Consult Manufacturer	Up to 100 Watts 20 - 600 RPM	1 to 100 gallons	30" FMB	Closed	 Top Entry	Autoclavable Sanitary Mixers for Small and Medium Batch Sizes
 <p>Cirrus Mixer</p>	1/4 - 2HP 1150 - 1750 RPM	1/4 - 2HP 175 - 350 RPM 1/4 - 3/4HP Up to 350 RPM	5 to 1,000 gallons	72" FMB	Closed	 Top Entry	Heavy Duty Sanitary Mixer for Medium Size Batches
 <p>Flow Series</p>	N/A	1/4 - 100HP 3 - 450 RPM	50 to 1,000,000 gallons	360" FMB (30 feet)	Open or Closed	 Top or Side Entry	Large Scale Industrial and Sanitary Gear Drive Mixers
 <p>Drum Series</p>	1/2 - 3HP 1150 - 1750 RPM	1/2 - 3HP 230 - 350 RPM	55 gallons (typically)	30" FMB	Open or Closed	 Top Entry	Standard and Custom Drum Mixers
 <p>Tote Series</p>	1/2 - 3HP 1150 - 1750 RPM	1/2 - 3HP 230 - 350 RPM	275 to 575 gallons (typically)	36" FMB	Open or Closed	 Top Entry	Standard and Custom Tote Mixers
 <p>Lift Stands</p>	Built to Suit						
 <p>Turnkey Systems</p>	Built to Suit						
 <p>Specialized Lab Mixers</p>	1/10 - 10HP 870 - 3600 RPM	1/10 - 10HP 4 - 500 RPM	As Req'd	36" FMB	Open or Closed	 Top Entry	Custom Lab Mixers

Need something different? Look to our Custom Mixers for additional solutions!

Options Overview							
Mounts		Motor Options		GearBox Options	Tank Seals	Shaft and Impeller Surface Treatments	
	Highly Adjustable Portable Mount	Electric TEFC Painted	Stainless Air Motor	Parallel Shaft with Helical Gears	FDA-compliant Rulon Lipseal	Passivation Processing	Cold Tar Epoxy Coating
	Highly Adjustable Fixed Mount	Electric TENV Painted	Painted Air Motor	Right Angle with Helical Bevel Gears	Viton Lipseal (food grade versions available)	Mechanical Polishing	Kynar Coating
	Vibration Dampening Fixed Mount	Electric Washdown Duty Painted	Inverter Duty	Right Angle with Worm Gears	EPDM Lipseal (food grade versions available)	Electropolishing (EP)	Halar Coating
	Add to Plate Mount for Optimal Mixing Angle	Chem Duty (Chemical Resistant)	DC Electric	Stainless Steel Construction	High or Low Pressure Stuffing Box	Natural Rubber Coating	PFA Teflon Coating
	Very Robust Open Tank Fixed Mount	Electric Explosion Proof Painted	50 Hz Electric	Synthetic Lube (Lubed for Life)	Mechanical Seal	Chlorbutyl Rubber Coating	ETFE Teflon Coating
	Very Robust Closed Tank Fixed Mount	Stainless Electric Washdown Duty	575 Volt Electric	FDA-compliant Lube	Double Mechanical Seal	PVC Coating	HTFE Teflon Coating
	Quick Change Closed Tank Fixed Mount						

We're glad to offer both standard and unique options for your application!

Additional Accessories Include:

Variable Frequency Drives "VFD" (Analog, Digital or Digital w/ Integral Disconnect); Tachometers; Emergency Stops/Shut Offs, Coatings, Seals & More.



Controls



Safety



Coatings



Seals



Fusion Pro Series

Portable and Fixed Mount Mixers



DESIGN INTENT

Lightweight, but rugged, this mixer series features a one-piece, investment-cast aluminum bearing housing with two oversize bearings for high performance and a long service life.

EXAMPLE APPLICATIONS

- Chemical Processing
- Petroleum
- Ethanol
- Biofuel
- Industrial Blending
- Industrial Mixing
- Waste Water Treatment
- Inks and Dyes & Much More!

SPECS

- Direct Drive: ¼ - 5HP
1150-1750 RPM
- Gear Drive ¼ - 5HP
175-350 RPM
- Batch: 5 to 3,000 Gallons
- Shaft Length:
Up to 120" FMB



Top Entry



www.fusionfluid.com



DIRECT DRIVE WITH FLANGE MOUNT



DIRECT DRIVE WITH CLAMP MOUNT



GEAR DRIVE WITH CLAMP MOUNT



FEATURES AND BENEFITS:

- Available to fit top entry configurations in open or closed tanks.
- Mixer-duty electric motors are available in a variety of sizes, phases, and voltages chosen based on your need. Washdown duty and explosion proof motors are optional. Air motors are also available.
- A complete line of gearboxes and accessories provides a wide range of mixing speeds to match your application. Gear drive units come standard with synthetic lubrication (lubed for life).
- Our unique one piece, aluminum investment-cast bearing support housing is available with an integrated ball and socket for clamp mount applications or an integral flange for sealed and beam mount applications. Our ball and socket style clamp mounts provide portability and ultimate flexibility while giving a wide range of adjustability that allows for optimal positioning.
- The dual bearing design provides added strength and durability. Pro Series Mixers are very easy to maintain; they disassemble and re-assemble in just minutes!
- Sealed tank configurations can be achieved through the use of various Lipseals, High Pressure Stuffing Boxes, and assorted Mechanical Seals.
- ALL mounting components are 300 series stainless steel. Wetted components are standard in 316L stainless steel.

MOUNTING OPTIONS:



Cup



Clamp



Plate



Plate with Angle Risers



ANSI Flange



TriClamp



GEAR DRIVE WITH CLAMP MOUNT



DIRECT DRIVE WITH CLAMP MOUNT



GEAR DRIVE WITH PLATE MOUNT

FEATURES AND BENEFITS:

- Available to fit top entry configurations in open or closed tanks.
- Stainless steel, washdown-duty electric motors are available in a variety of sizes, phases, and voltages chosen based on your need. Explosion proof motors and air motors are also available.
- A complete line of stainless steel gearboxes and accessories provides a wide range of mixing speeds to match your application. Gear drive units come standard with H1 grade sanitary synthetic lubrication (lubed for life).
- Our unique one piece, 300 series stainless steel investment-cast bearing support housing is available with an integrated ball and socket for clamp mount applications or an integral flange for sealed and beam mount applications. Our ball and socket style clamp mounts provide portability and ultimate flexibility while giving a wide range of adjustability that allows for optimal positioning.
- The dual bearing design provides added strength and durability. Pro Series Mixers are very easy to maintain; they disassemble and re-assemble in just minutes!
- Sealed tank configurations can be achieved through the use of FDA-compliant Lipseals, High Pressure Stuffing Boxes, and assorted Mechanical Seals.
- ALL mounting components are 300 series stainless steel. Wetted components are standard in 316L stainless steel.

MOUNTING OPTIONS:



Cup



Clamp



Plate



Plate with Angle Risers



ANSI Flange



TriClamp

DESIGN INTENT

This all stainless steel version of our Pro Series mixer is also lightweight and rugged. The one-piece, investment-cast stainless steel bearing housing has two oversize bearings for high performance and a long service life.

EXAMPLE APPLICATIONS

- Biopharmaceutical
- Food and Beverage
- Chemical Processing
- Industrial Blending
- Industrial Mixing
- Waste Water Treatment in Corrosive Conditions & Much More!

SPECS

- Direct Drive: ¼ - 2HP
1150-1750 RPM
- Gear Drive ¼ - 2HP
175-350 RPM
- Batch: 5 to 3,000 Gallons
- Shaft Length:
Up to 120" FMB



Top Entry

Fusion Axiom Mixer

Small Batch, Autoclave Sanitary Mixers

DESIGN INTENT

With a clean and simple design, these autoclave-capable, sanitary mixers are designed to meet your FDA, 3A, USP-VI, or BPE requirements.

EXAMPLE APPLICATIONS

- Pharmaceutical
- Biotechnology
- Food Preparation
- Beverage
- Corrosive Conditions & Much More!

SPECS

- Gearmotor:
 - 30-100 Watts;
 - 20-600 RPM
- Batch: 1 to 100 Gallons
- Shaft Length: 18" Std; Up to 30" FMB



Top Entry



ELECTRIC MOTOR WITH ANSI FLANGE MOUNT



PNEUMATIC MOTOR WITH TRICLAMP MOUNT



ELECTRIC MOTOR WITH TRICLAMP MOUNT

FEATURES AND BENEFITS:

- Sanitary mixers for top entry configurations with sealed tanks.
- Ultra-clean mixer design allows easy disassembly for autoclave sanitation processes. Housings have integral 2" TC mount and are standard in FDA plastic (USPVI), yet other TC adapters are available.
- Electric gearmotors (IP65 and ROHS compliant) provide up to 100 watts at constant torque from 20-600 RPM.
- Featured seal options include FDA Rulon lipseals (USPVI) or carbon/ceramic/Viton mechanical seals.
- Shafts and impellers are standard in 316L stainless steel. We offer a variety of impeller styles and sizes to choose from based upon the need of your application.
- All wetted parts are finished to 20Ra as standard, with 15Ra and 8Ra polished finishes optional. Passivation and electropolish are also available.

MOUNTING OPTIONS:



ANSI Flange



TriClamp Flange



See Pg. 19 for Sanitary Impeller Details.

Fusion Cirrus Mixer

Medium Batch, Stainless Sanitary Mixers



GEAR DRIVE WITH MECHANICAL SEAL



DIRECT DRIVE WITH FDA LIPSEAL

FEATURES AND BENEFITS:

- ✱ Stainless steel sanitary mixers for top entry configurations with sealed tanks.
- ✱ Mixer-duty electric and air powered motors are available with a wide variety of sizes, phases, and voltages. Special motor features include washdown duty, explosion proof, DC electric, inverter duty, and many more.
- ✱ We provide you with a complete line of stainless steel gearboxes and accessories to match your application's needs.
- ✱ Sanitary mixer designs utilize 300 series stainless steel housings with dual bearings allowing reduced vibrations and longer shaft lengths (up to 72" FMB). Our housings provide easy access and quick maintenance of seal components.
- ✱ Various seal options include FDA Rulon, EPDM, and Viton lipseals, mechanical seals and more. These availabilities help to address any special demands of your application.
- ✱ All wetted parts are standard in 316L stainless steel with passivation and electropolish available. We offer a variety of impeller styles and sizes to choose from based upon the need of your application.

MOUNTING OPTIONS:



ANSI Flange



TriClamp Flange



See Pg. 4 for Shaft and Impeller Coating Options.

DESIGN INTENT

These heavy duty, all stainless steel, sanitary mixers are designed to meet your sanitary requirements for medium-sized batches or in applications where higher pressures exist.

EXAMPLE APPLICATIONS

- Pharmaceutical
- Biotechnology
- Food Preparation
- Beverage
- Corrosive Conditions & Much More!

SPECS

- Direct Drive: ¼ - 2HP
1150-1750 RPM
- Gearmotor: ¼- ¾ HP
Up to 350 RPM
- Batch: 5 to 1,000 Gallons
- Shaft Length:
Up to 72" FMB



Top Entry

Fusion Flow Series – Parallel Shaft

Flexible Large Scale Mixers

DESIGN INTENT

Heavy-duty and extremely flexible, the Flow Series Parallel Shaft mixers are designed to meet the needs of your large scale industrial, chemical or sanitary mixing applications.

EXAMPLE APPLICATIONS

- Industrial Mixing & Blending
- Large Scale Sanitary and BioPharm
- Reaction Tanks
- Low or High Viscosity Blending
- Large Scale Waste Treatment & Much More!

SPECS

- Gear Drive: ¼ - 100HP
3-400 RPM
- Batch: 50 to 1,000,000 Gallons
- Shaft Length:
Up to 360" FMB

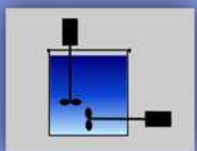

Top or Side Entry



www.fusionfluid.com



PARALLEL SHAFT
DRIVE MIXERS



SEVERAL TYPES OF
PRESSURE RATED
SEALS AVAILABLE

FEATURES AND BENEFITS:

- Mixer-duty electric motors are available in a variety of sizes, phases, and voltages chosen based on your need. Other options include washdown duty, inverter duty, DC electric, and explosion proof motors. Air motors are also available.
- A complete line of double-helical, parallel shaft gearboxes with multiple gear ratios is available for quiet and efficient operation per your application. Gearboxes come standard with synthetic lubrication (lubed for life). Minimum of 1.5 mechanical service factor on all gearing and bearings.
- Virtual drywells and heavy-duty output bearings are typically used on large units for reduced vibration and to allow for longer shaft lengths. Rigid in-tank couplings used as required.
- Closed Tank configurations are available with vapor seals, stuffing box glands (up to 150 PSI) and single or double mechanical seals (300+ psi). In-tank shutoff mechanism allows seal changes on side entry mixers without emptying the tank.
- Stainless Steel components, Steel-It™ USDA-compliant paint, polished shafts and various shaft coatings are available for sanitary applications and chemical resistance.
- Various impeller styles and mounting options such as ANSI flange mount, TriClamp mount, beam mount are available for your process.

MOUNTING OPTIONS:



ANSI
Flange



TriClamp
Flange



Beam



Fusion Flow Series – Right Angle Drive

Flexible Large Scale Mixers



STAINLESS MOTOR AND WORM DRIVE



STANDARD WORM DRIVE WITH STUFFING BOX



HELICAL-BEVEL DRIVE MIXER



STAINLESS WORM DRIVE MIXER WITH SANITARY MOTOR

FEATURES AND BENEFITS:

- ✱ Mixer-duty electric motors are available in a variety of sizes, phases, and voltages chosen based on your need. Other options include washdown duty, inverter duty, DC electric, and explosion proof motors. Air motors are also available.
- ✱ Many right angle gearbox options are available that require less space in restricted areas:
 - Helical-bevel gearboxes with double or triple reduction gear arrangements provide quiet operation and extended life. Hundreds of gear ratios are available.
 - Worm drive gearboxes offering single or double reduction worm gear arrangements allow high shock loading and economical design. Choose from 13 gear ratios to match process requirements.
 - Minimum of 1.5 mechanical service factor on all gearing and bearings.
- ✱ Virtual drywells and heavy-duty output bearings are typically used on large units for reduced vibration and to allow for longer shaft lengths (available with Helical-Bevel gearboxes). Rigid in-tank couplings used as required.
- ✱ Closed Tank configurations are available with vapor seals, stuffing box glands (up to 150 PSI) and single or double mechanical seals (300+ psi). In-tank shutoff mechanism allows seal changes on side entry mixers without emptying the tank.
- ✱ Stainless Steel components, Steel-It™ USDA-compliant paint, polished shafts and various shaft coatings are available for sanitary applications and chemical resistance.
- ✱ Various impeller styles and mounting options such as ANSI flange mount, TriClamp mount, beam mount are available for your process.

MOUNTING OPTIONS:



ANSI Flange



TriClamp Flange



Beam



DESIGN INTENT

Heavy-duty and flexible, the Flow Series Right Angle mixers are designed to meet the needs of your large scale mixing applications.

EXAMPLE APPLICATIONS

- Industrial Mixing & Blending
- Large Scale Sanitary and BioPharm
- Reaction Tanks
- Low or High Viscosity Blending
- Large Scale Waste Treatment & Much More!

SPECS

- Gear Drive: ¼ - 100HP
3-450 RPM
- Batch: 50 to 1,000,000 Gallons
- Shaft Length: Up to 360" FMB

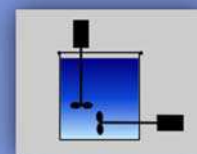

Top or Side Entry



www.fusionfluid.com

Fusion Drum Series

Drum Mixers

DESIGN INTENT

Fusion Drum mixers are designed for quick setup and enhanced portability while providing uniform drum mixing. Standard and custom designs are available to meet your needs.

EXAMPLE APPLICATIONS

- Industrial Drum Mixing & Blending
- Material Storage
- Chemical Drum Mixing
- Low or High Viscosity Batches
- Subtle or Aggressive Agitation

SPECS

- Direct Drive: ½ - 3HP
1150-1750 RPM
- Gear Drive: ½ - 3HP
230-350 RPM
- Batch: 55 gallons (typical)
- Shaft Length: 30" FMB



Top Entry



www.fusionfluid.com



VAPOR-TIGHT DRUM MIXER WITH VFD



2" NPT BUNG MOUNT DRUM



CUSTOM HIGH VISCOSITY DRUM LID MIXER



FEATURES AND BENEFITS:

- Fusion's drum mixers are versatile, light-weight, stable, and provide uniform mixing.
- Bung Mount mixers enter through and attach directly to the 2" NPT Bung that is common to most drums. Our version accepts Viton, EPDM, and FDA Rulon lipseals to provide additional protection for your product.
- Drum Lid Mount mixers are mounted directly to a standard 22" diameter steel drum lid and can be moved from drum to drum. Custom heavy-duty lids also offered.
- Industrial-duty TEFC electric motors are standard and are available in a variety of sizes, phases, and voltages chosen based on your need. Washdown duty and explosion proof motors are optional. Air motors are also available.
- Complete line of gearboxes and accessories provides a wide range of mixing speeds to suit your needs.
- Single or dual 316L stainless steel folding impellers are positioned on a 316L stainless steel shaft.
- All stainless steel versions and other impeller styles are also available. Custom drum mixers can be designed and built to your application's specifications.



2" DRUM BUNG FOLDING IMPELLERS DESIGNED FOR LIMITED-ACCESS VESSELS

Fusion Tote Series

Tote Mixers

Most Tote Mixers
SHIP NEXT
BUSINESS DAY
When ordered by 1:30pm EST

**BRIDGE MOUNT TOTE MIXER
WITH OPTIONAL FORK
CHANNELS AND VFD**



**CAP MOUNT
TOTE MIXER**



**BRIDGE MOUNT
TOTE MIXER WITH
FOLDING IMPELLERS**

FEATURES AND BENEFITS:

- Fusion's tote mixers are versatile, light-weight, stable, and provide uniform mixing.
- Bridge Mount tote mixers offer an ultra robust platform for aggressive mixing. These attach across the top rails of cage style totes that are up to 52" wide, and can quickly and easily be moved from tote to tote.
- Cap Mount Tote mixers mount directly to a Schutz style 6" screw cap. Our tie rod mounting kit is included to provide additional stability.
- Industrial-duty TEFC electric motors are standard and are available in a variety of sizes, phases, and voltages chosen based on your need. Washdown duty and explosion proof motors are optional. Air motors are also available.
- Complete line of gearboxes and accessories provides a wide range of mixing speeds to suit your needs.
- Single or dual 316L stainless steel folding impellers or marine impellers are located on a 316L stainless steel shaft.
- All stainless steel versions and other impeller styles are also available. Custom tote mixers can be designed and built to your application's specification.



**TOTE STYLE FOLDING
IMPELLERS DESIGNED FOR
LIMITED-ACCESS VESSELS**

DESIGN INTENT

Fusion Tote mixers are designed for quick setup and enhanced portability while providing uniform tote mixing. Standard and custom designs are available to meet your needs.

EXAMPLE APPLICATIONS

- Industrial Tote Mixing & Blending
- Material Storage
- Chemical Tote Mixing
- Low or High Viscosity Batches
- Subtle or Aggressive Agitation
- Small Systems

SPECS

- Direct Drive: ½ - 5HP
1150-1750 RPM
- Gear Drive: ½ - 3HP
230-350 RPM
- Batch: 275 to 575 gallons
- Shaft Length:
36" FMB



Top Entry



www.fusionfluid.com

Fusion Custom Lift Stands

DESIGN INTENT

Fusion Lift Stands are designed to support your process and fit the needs of your application. Each stand is designed in 3D prior to fabrication to ensure a successful implementation of features. Review the available options, and contact us to discuss your project in further detail!

EXAMPLE APPLICATIONS

- Industrial Mixing
- Chemical Processing
- Corrosive Conditions
- Pharmaceutical
- Biotechnology
- Food/Beverage & Much More!

Fusion proudly offers custom mixer stands so you don't need to settle on a generic stand that doesn't fit your application perfectly. When engineering your stand, we model the design in 3D before fabrication to ensure a robust design and proper function. Your process is important and it deserves the right support.

**MOBILE STAINLESS
STAND WITH
MANUAL WINCH
AND POLISHED
SANITARY FINISH**



**MOBILE STAND
WITH ELECTRIC
WINCH AND
PAINTED FINISH**



**STATIONARY HEAVY-DUTY
STAND WITH PNEUMATIC
LIFT AND PAINTED FINISH**



CENTREX
TECHNICAL SALES

FF FUSION
FLUID EQUIPMENT

www.fusionfluid.com

OPTIONS INCLUDE:

- Stationary or Mobile
- All Stainless or Painted
- Sanitary / 3A Rated
- Manual or Electric Winches
- Pneumatic Lifts
- Control Mounts & Much More!

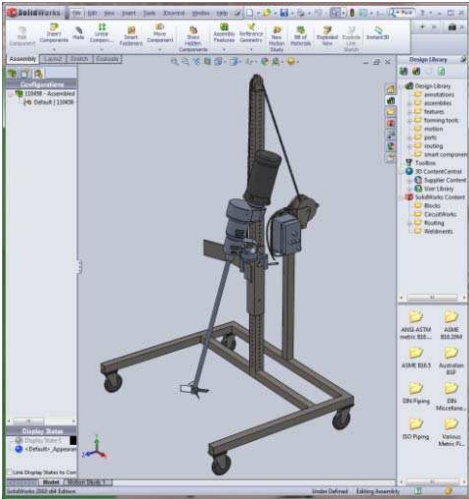

3D MODEL BEFORE FABRICATION



AFTER FABRICATION

MOBILE STAND WITH PNEUMATIC LIFT AND PAINTED FINISH



STATIONARY STAINLESS STAND WITH PNEUMATIC LIFT AND POLISHED SANITARY FINISH



Fusion Turnkey Systems

DESIGN INTENT

Fusion Turnkey Systems allow complete customization for your unique process requirements. Review the available options, and contact us to discuss your project in further detail!

EXAMPLE APPLICATIONS

- Industrial Mixing
- Chemical Processing
- Corrosive Conditions
- Pharmaceutical
- Biotechnology
- Food/Beverage
- Reaction Tanks & Much More!

DUAL SHAFT SANITARY MIXING SYSTEM - EXTERIOR



DUAL SHAFT SANITARY MIXING SYSTEM - INTERIOR

When you require more than a mixer, Fusion will confidently design and build an entire turnkey mixing system to accommodate your process needs. Designs include mixers, tanks or other mixing vessels, and are available as stationary or mobile arrangements as required. Our access to endless accessories and instruments allow effective configurations that perform as desired. When you're faced with a challenging project that may intimidate others, let us put our resources and experience to work for you!



TWO-STAGE RIBBON BLENDING SYSTEM WITH TOP MIXING TANK AND LOWER STORAGE & AGITATION TANK

OPTIONS INCLUDE:

- Mixers
- Tanks
- Pumps
- Valves
- Autoclave-Safe Components
- Heat Exchangers
- Dust Collection
- Screw Feeders & Solids Addition
- Scales/Load Cells
- Plumbing
- Pneumatics
- Controllers
- Touch-Screen Displays
- PLC Programming
- Complete Automation
- Skid Systems & Much More!



**HIGH VISCOSITY
PHARMACEUTICAL
MIXING & DISPENSING
SYSTEM**



**SINGLE-STAGE RIBBON BLENDING
SYSTEM WITH HELICAL IMPELLER AND
MOBILE MIXING VESSEL ON CART WITH
PNEUMATIC LIFT**



**MOBILE
PHARMACEUTICAL
MIXING SYSTEM**



**SANITARY MOBILE MIXING
STATION WITH DUAL MIXERS**



Fusion Lab Mixers

Specialized & Modular Lab Mixers

DESIGN INTENT

Fusion's Specialized Lab Mixers are produced for your specific process and your application is always approached with the quality and flexibility that it demands.

EXAMPLE APPLICATIONS

- Lab Mixers
- Dispersers
- High Speed Mixers
- High Shear Mixers
- Homogenizers
- Dissolvers
- & Much More!

LAB MIXER SPECS

- Direct Drive: 1/10-10HP
870-3600 RPM
- Gear Drive: 1/10- 10HP
4-500 RPM
- Batch: As Req'd
- Shaft Length:
Up to 36" FMB



**FLOW SERIES
HIGH VISCOSITY
LAB MIXER**



**PRO SERIES LAB
MIXER**

**MOD MIXER
WITH STAND**

Fusion is pleased to offer lab mixing solutions for specific application needs. When you require specialized equipment that can't be found in catalogs or from off-the-shelf suppliers, let's work together! Each project is viewed as unique, is given the attention it deserves, and is designed in a creative and knowledgeable manner. With our application and design expertise, extensive network of suppliers, 3D modeling, and custom fabrication capabilities, Fusion is well-equipped to provide unique solutions for your lab mixing process.



Top Entry



Fusion MOD Mixer Variable Speed Modular Mixers

- 0-1000 RPM Variable Speed Motor
- Lightweight less than 8 pounds!
- Various Mounting Options
 - 2" Tri Clamp
 - 2" NPT Drum/Tote Mount
 - Universal Clamp
- Stainless Steel Shafts - Up to 30" Long
- Stainless Steel Impellers Styles



IMPELLER STYLES

Fusion Custom Mixers

Custom Solutions for Specific Applications



MAGNETIC DRIVE MIXER

**DUAL CONCENTRIC
SHAFT MIXER**



When you need custom engineered equipment for your specific process, you want Fusion. Offerings span a wide range from highly customized mixers to our standard mixers that have been modified and accessorized. Properly sized valves, controls, and fittings are important to ensure optimal performance, safety, efficiency, and longevity of your equipment.

With our application and design expertise, extensive network of suppliers, 3D modeling, and numerous other custom fabrication capabilities, Fusion is prepared to provide unique solutions for your custom mixing needs. Your expectations will be exceeded by our ability to offer the highest level of customer-specified options available in the mixer market. Let us construct the right equipment and accessories for your project!

DESIGN INTENT

We realize that every application is different. We also realize that not all applications can be handled with standard mixers. This is why we are pleased to offer customized solutions for those who have specific process needs.

EXAMPLE APPLICATIONS

- High Viscosity Mixing
- Sanitary & BioPharm
- Special Process
- Chemical Resistance
- Automation

SPECS

- Direct Drive: 1/40-100HP
870-3600 RPM
- Gear Drive: 1/20 - 100HP
4-720 RPM
- Batch: As Req'd
- Shaft Length:
Up to 360" FMB

BOTTOM ENTRY MIXER











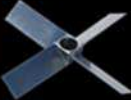

BELT DRIVE MIXER



Impellers by Fusion

Impeller Styles & Details

Fusion Impeller Styles			
Impeller	Description	Power Number (N _p)	Pumping Number (N _a)
 Marine Style	The Marine Style is the most common type of mixing impeller. Because the design has its roots in the marine propulsion industry, it is the most effective axial pump at higher mixing speeds. It is most commonly used with direct drive mixers operating 900-1800RPM. This impeller fits the most common shaft sizes (5/8" to 1-1/4") and comes standard in investment CAST 316 Stainless Steel. The Power and Flow numbers shown above reflect 1.0 pitch/diameter ratio. Fusion also offers 1.5 pitch/diameter ratio upon request.	0.34	0.50
 PF3 Hydrofoil	The modern design of this PF3 Hydrofoil impeller provides excellent pumping ability with a strong axial flow. While useful in most applications, this design excels in thinner fluids that are susceptible to settling and provides the MOST pumping per unit of torque (more bang for your buck). This impeller is available as a welded or bolted assembly. The PF3 impeller can be fabricated to fit ANY shaft diameter and comes standard in 316 Stainless Steel. Various surface finishes are available. Fusion also offers high-viscosity designs (10,000 cP+) for special applications requiring axial flow in thick fluids.	0.30	0.50
 Pitch Blade Turbine	This Pitch Blade Turbine impeller is the workhorse of the mixing industry. The simple design of this impeller provides a combination of both radial and axial flow, generates high shear levels, and provides excellent mixing ability while providing easy cleanup. Because of the simple design, it is also very cost effective in large applications and high viscosity applications. While useful in most applications, this design excels in heavy mixing. The PBT impeller can be fabricated to fit ANY shaft diameter and comes standard in 316 Stainless Steel. Various surface finishes are available.	1.27	0.79
 Rushton	The Rushton impeller, named after its designer, is one of the first mixing impeller designs to be documented. The classic design of this impeller provides a simple radial flow pattern that moves material from the center of the vessel outward where it flows along the outer walls of the tank. It is most commonly used in reactor tanks, two phase mixing (liquid/gas), and any application requiring INTENSE mixing. This impeller can be fabricated to fit ANY shaft diameter and comes standard in 316 Stainless Steel. Various surface finishes are available.	5.75	0.72
 Cowles/Sawblade	The Cowles/Sawblade design of this impeller provides mixing by generating high shear levels. This design is most commonly used in applications where the high shear levels are needed to prevent clumping. The Cowles/Sawblade is suggested for use in wetting out powders, dispersing fine solids, and creating emulsions. This impeller can be fabricated to fit almost any shaft diameter and comes standard in 316 Stainless Steel. Various surface finishes are available.	0.45	0.26
 BioProp - Sanitary (Marine Style)	The BioProp - Marine Style impeller was developed by Fusion engineering and our key biotech distributors to serve the sanitary and biotech markets. This new design provides excellent pumping ability while providing easy cleanup. The most important characteristic of this impeller is that it provides similar performance to the marine propeller, but it is fabricated from mill stock. Impellers from polished mill stock do not have the casting porosity commonly found in Marine-style impellers. This impeller can be made to fit ANY shaft diameter. It comes standard in 316 Stainless Steel. Various surface finishes are available.	0.40	0.45
 BioProp - Sanitary (Mass Flow)	The BioProp Mass Flow impeller was designed for sanitary and biotech applications that require advanced pumping rates. The wide blades of the Mass Flow BioProp impeller deliver very high pumping rates in a compact package. Like the original BioProp, the manufacturing and design allows for sanitary finishes and coatings, which supports easy cleanup and sanitation. This impeller can be made to fit ANY shaft diameter. It comes standard in 316 Stainless Steel. Various surface finishes are available.	3.00	0.74
 Retreat	The unique design of a Retreat impeller provides a simple radial flow pattern that moves material from the center of the vessel outward where it flows along the outer walls of the tank. An added benefit to this design is that it provides radial flow with a significantly low amount of shear, making it perfect for shear sensitive fluids. Due to the skewed blade design, the Retreat also resists build-up of fibrous solids on the blades. This impeller can be fabricated to fit ANY shaft diameter and comes standard in 316 Stainless Steel, but 304 Stainless Steel, Aluminum, and Carbon Steel versions are also available. Various surface finishes are available.	2.52	0.74
 Folding Impellers	The Folding impeller is most commonly used in applications where access to the vessel is limited, such as drum mixers and tote mixers. The folding design allows the impeller and shaft to be inserted and retracted through the entry hole of the vessel to be mixed. The Folding Impeller provides a combination of both radial and axial flow, generates high shear levels, and provides excellent mixing ability while allowing easy mixer installation and removal. The Folding Impeller comes standard in 316 Stainless Steel. Various surface finishes are available too.	0.50	0.50
 Custom Impellers	Custom impellers, including helical and ribbon impellers can be produced to your exact specifications supporting your specific tank geometry and protected proprietary processes. We can also design and produce replacement impellers, or modified and hybrid versions of other designs in a variety of materials, including 304 Stainless Steel, 316 Stainless Steel, Hastelloy, Aluminum, or Carbon Steel.	-	-

Most impellers are available in other materials, like 304SS, Hastelloy, Aluminum, Carbon Steel, & Teflon.



POLY COWLES IMPELLER



**HASTELLOY DOUBLE
HELIX WITH
CUSTOM KICKER
BLADE**



SQUIRREL IMPELLER



**HORIZONTAL HELIX
RIBBON IMPELLER**



**VERTICAL HELIX/ANCHOR
WITH CENTER AUGER**

**AUTOMATED PARTS
WASHING SYSTEM**



Fusion welcomes custom fabrication opportunities at our facility- we're more than a mixer manufacturer! With our application and design expertise, extensive network of suppliers, 3D modeling, and numerous other custom fabrication capabilities, Fusion is prepared to provide you with detailed custom fabricated pieces. We'll put our resources to work for you when others may be intimidated or uninterested.

DESIGN INTENT

Fusion will put its talent and resources to work for you when special fabrication needs arise. We enjoy offering solutions to your process challenges!

EXAMPLE APPLICATIONS

- Tank Specific Anchor (Paddle) Impellers
- Complex Helical Impellers
- Custom Fittings and Adapters
- Custom Mounts or Braces
- Custom Mixing Stands
- Process Specific Systems and Components

CAPABILITIES

- 3D Modeling
- CNC Machining
- Laser Cutting
- Water-jet Cutting
- Mechanical Forming
- MIG & TIG Welding
- Electropolishing
- Polishing
- Passivation
- Coatings

FIXED MOUNT WITH BAFFLES

- Optimal for top entry.
- Mount mixer vertically in the center of the tank.
- Three or four baffles should be spaced evenly around tank. Four baffles are preferred. (top left)
- Tank manufacturer should determine baffle thickness and mounting.

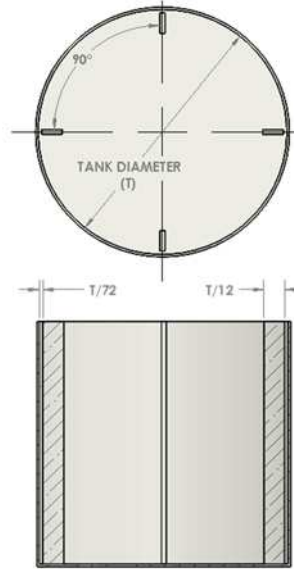

FIXED MOUNT WITH OPTIMAL BAFFLES

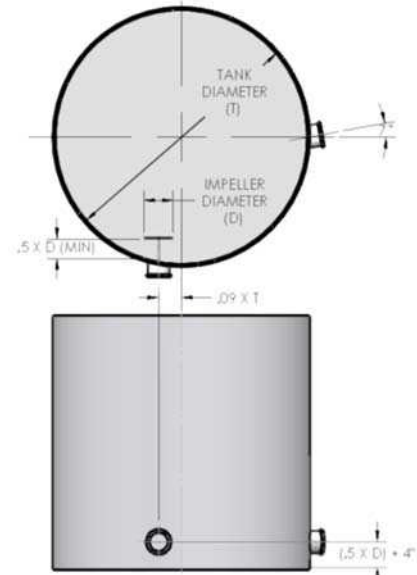

SIDE ENTRY MOUNT

SIDE ENTRY

- Optimal for side entry.
- Mount mixer horizontally.
- There are two preferred mountings – offset and angled. (top right)
- All mounting bolts on flange should “straddle center”.

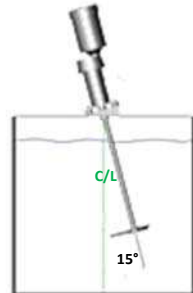

**FIXED ENTRY – NO BAFFLES
CYLINDRICAL TANK**

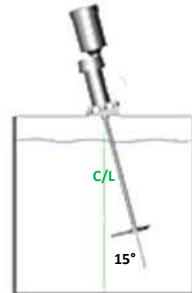

**FIXED ENTRY – NO BAFFLES
SQUARE TANK**

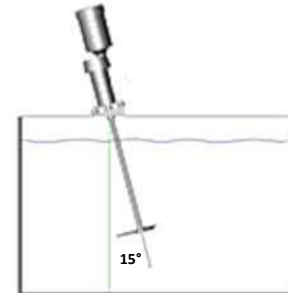

**FIXED ENTRY – NO BAFFLES
RECTANGULAR TANK**

OTHER TOP ENTRY CONFIGURATIONS

- Mixers without baffles should be oriented 15° from vertical for optimal flow pattern.
- Mixers without baffles should be offset to the right of center (as shown) to prevent vortexing.
- For large applications, use a vertical offset mount where mixer is oriented vertically and offset from tank center by 1/4 of the tank diameter (T), as allowed by the impeller diameter (D).

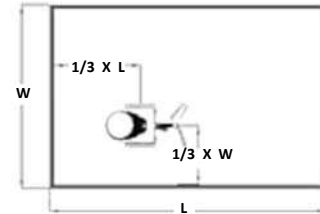
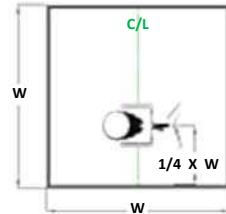
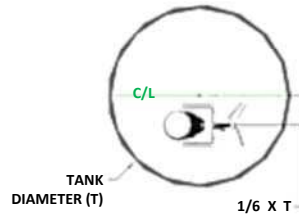

FIXED MOUNT MIXERS WITHOUT BAFFLES

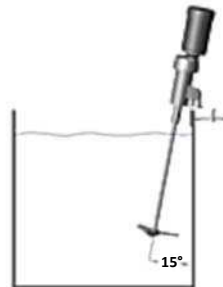

**CLAMP MOUNT – NO BAFFLES
CYLINDRICAL TANK**

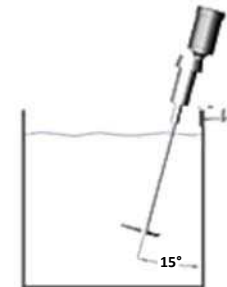

**CLAMP MOUNT – NO BAFFLES
SQUARE TANK**

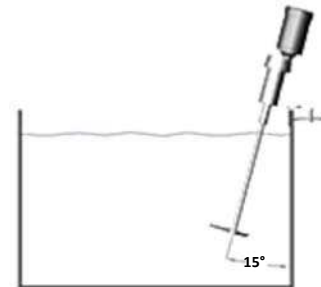

**CLAMP MOUNT – NO BAFFLES
RECTANGULAR TANK**

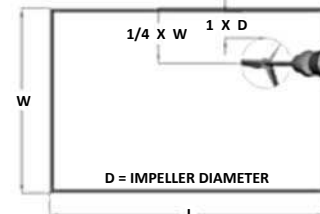
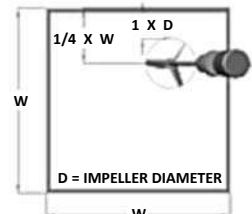
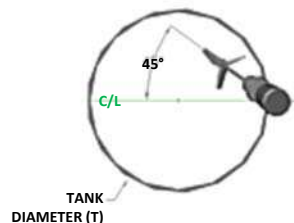

CLAMP MOUNT MIXERS WITHOUT BAFFLES