



# Manual or Automatic - it's your Choice

## LKB Automatic or Manual Butterfly Valve

### Application

LKB is a sanitary automatic or manually operated butterfly valve for use in stainless steel fluid handling systems.

### Working principle

LKB is either remote-controlled by means of an actuator or manually operated by means of a handle. The actuator is made in three standard versions, normally-closed (NC), normally-open (NO) and air/air-activated (A/A).

The actuator is designed so that an axial movement of a piston is transformed into a 90° rotation of a shaft. The torque of the actuator is increased when the valve disc contacts the seal ring of the butterfly valve.

A variety of handle options for manual operation mechanically secures the valve in its open, closed, or intermediate positions.

### Standard design

The valve consists of two valve body halves, valve disc, bushings for the disc stem and seal ring. The valve is assembled by means of screws and nuts.

Two actuator sizes,  $\varnothing$  85 mm (3.35") and  $\varnothing$  133 mm (5.24"), cover all valve sizes.

The actuator is fitted onto the valve by means of a bracket and screws.

The handle for manual operation is fitted onto the valve by means of a cap/block system and a screw.

The LKB is available with either welded ends or Tri-Clamp® sanitary connections.

### Control Equipment

Control and indication is possible in connection with the remote-controlled LKB valve, including the ThinkTop®. See "Options".



LKB butterfly valve with handle

## Capacity/Pressure drop diagrams

LKB fully open

### Torque values (for rotating the valve disc in a dry seal ring)

Valve Size	Max Torque (ft-lbs)
1-inch	13
1.5-inch	13
2-inch	15
2.5-inch	15
3-inch	15
4-inch	28
6-inch	28

**Note!**For the diagrams the following applies:

Medium: Water (155°F).

Measurement: In accordance with VDI 2173.

## Valve Dimensions (inches)

Size	1-inch	1½-inch	2-inch	2½-inch	3-inch	4-inch	6-inch
C	1.75	1.75	1.85	1.88	2.03	2.38	3.06
D	3.50	3.50	3.69	3.75	4.06	4.75	6.13
E	1.53	1.53	1.94	2.31	2.59	3.34	4.25
F	3.07	3.07	3.90	4.61	5.20	6.65	8.46
H <sup>1</sup>	1.85	1.85	2.05	2.13	2.44	3.15	3.15
J	3.23	3.23	3.62	4.02	4.21	5.00	5.98
J (green handle)	4.00	4.00	4.38	4.78	4.97	5.75	6.19
K (black handle)	4.72	4.72	4.72	4.72	6.38	6.38	6.34
K (green handle)	6.31	6.31	6.31	6.31	6.31	6.31	14.50
Weight LKB (lbs.)	2.64	2.20	3.31	4.63	10.36	19.84	-

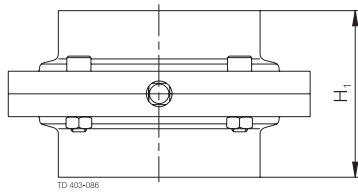

a. LKB with welding ends

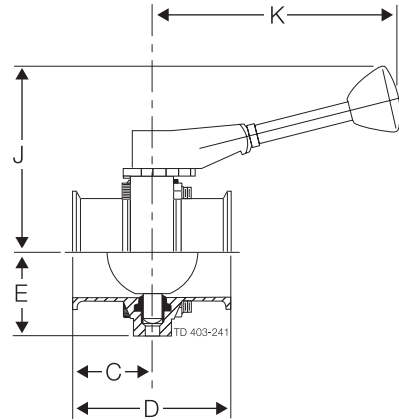

b. LKB multi-position green handle

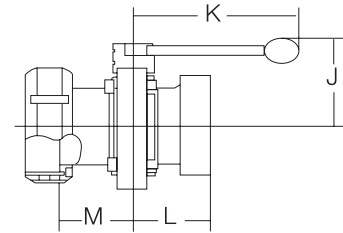

c. LKB with male part/nut and liner

## Actuator Dimensions (inches)

### LKLA and LKLA-T

Size	1-inch Ø85 mm	3-inch Ø85 mm	4-inch Ø85 mm	4-inch Ø133 mm	6-inch Ø85 mm	6-inch Ø133 mm
A1	9.61	9.53	9.53	14.29	9.69	14.29
A2	7.60	7.52	7.52	12.44	7.68	12.44
F	8.56	9.44	10.25	15.38	11.55	16.31
G	10.13	12.06	13.56	18.70	15.80	20.56
H	2.72	3.59	4.38	5.60	5.60	6.50
I	0.65	0.65	0.65	1.34	0.64	1.34
s	0.31	0.39	0.47	0.47	0.59	0.59
Function	NC,NO,A/A	NC,NO,A/A	NC,NO,A/A	NC,NO,A/A	A/A	NC,NO,A/A

**Note!** Suitability depends on process conditions

Figure 4. Dimensions - actuator

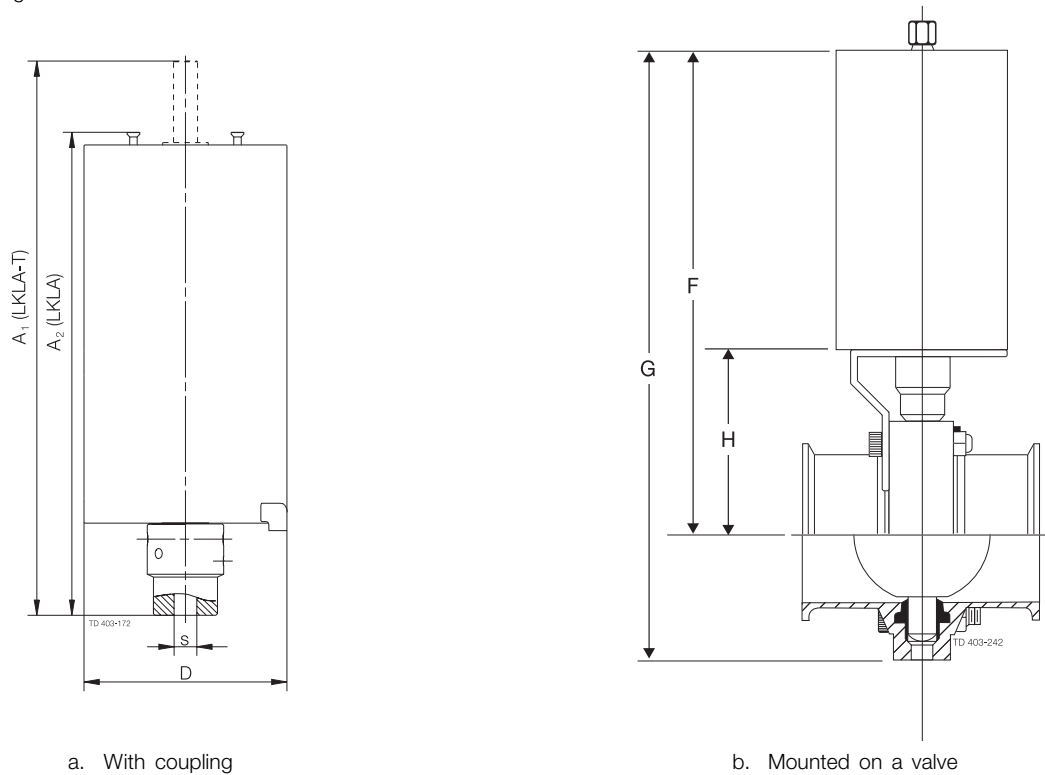

## Connections

### Compressed air

R1/8" (BSP), internal thread.

(Quick connect fittings for 1/4" tubing provided as standard)

## Technical Data

### Valve:

Max. product pressure: . . . . .145 PSI (10 bar)  
Min. product pressure: . . . . .Full vacuum.  
Temperature range: . . . . .15 °F to 200 °F

### Actuator:

Max. air pressure: . . . . .100 PSI (7 bar)  
Min. air pressure, NC and NO: . . . . .60 PSI (4 bar)  
Temperature range: . . . . .15 °F to 195 °F  
Air consumption (litres free air) - ø85 mm: . . . . .0.24 x p (bar)  
Air consumption (litres free air) - ø133 mm: . . . . .0.95 x p (bar)  
Weight:

ø85 mm . . . . .6.6 lbs  
ø133 mm . . . . .26.4 lbs

## Materials

### Valve:

Product wetted steel parts: . . . . .304 stainless steel or 316L stainless steel  
Valve Disc . . . . .316L stainless steel  
Other steel parts: . . . . .304 stainless steel  
Rubber grades: . . . . .Silicone rubber (Q), EPDM, Fluorinated rubber (FPM), PFA (bonded over  
EPDM), or HNBR  
Bushes for valve disc: . . . . .PVDF.  
Finish OD . . . . .Machined finish  
Finish ID  
Sanitary . . . . .≤ 32 microinches Ra  
Industrial . . . . .(not polished)

### Actuator:

Actuator body: . . . . .304 stainless steel  
Piston: . . . . .Light alloy (for ø85 mm: Bronze).  
Air/air version (Bronze)  
Seals: . . . . .Nitrile (NBR).

## Options

- A. Tri-Clamp® or butt weld ends standard
  - other connections available upon request
- B. ThinkTop® for control and indication
- C. Green Top - position indication MS or PS
- D. Indication unit with micro switches
- E. Indication unit with inductive proximity switches
- F. Handle with two or four positions (standard on 6")
- G. Handle for electrical position indication
- H. Handle with infinite intermediate positions (not for 6")
- I. Multi-positioning handle with lever handle or pull knob
- J. Service tool for actuator
- K. Service tool for fitting 1"-1.5" valve discs

## LKB Handle Options

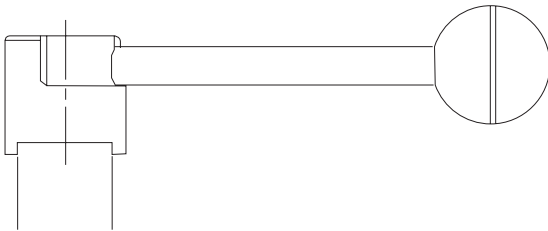

Fig. 5. LKB two position handle (black handle)

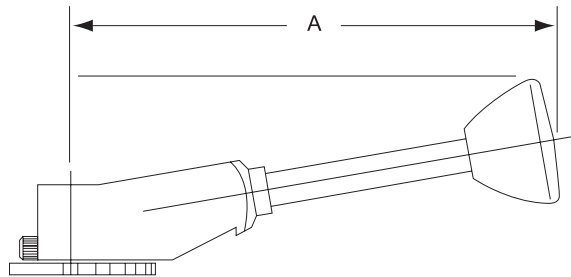

Fig. 6. LKB multi-position handle (green handle)

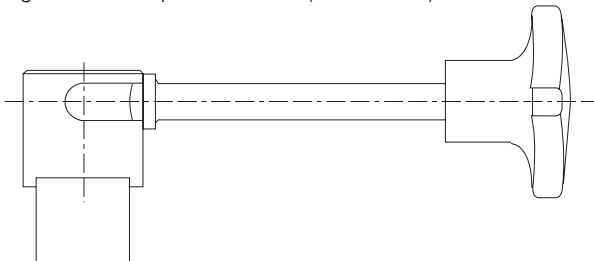

Fig. 7. LKB butterfly valve regulating handle

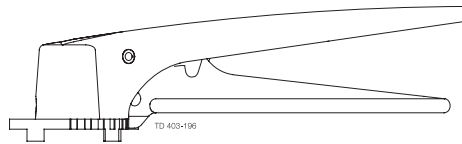

Fig. 8. LKB lockable multi-position handle

## Ordering

Please state the following when ordering:

- Valve size
- Connections
- Materials: AISI 304 or AISI 316L
- Rubber grade: EPDM, Silicone (Q), Fluorinated rubber (FPM) or HNBR, PF (PTPE coated EPDM (1½" or large) or N.A. in 1" size
- Type of handle, if required

### If ordering with actuator:

- Type: LKLA or LKLA-T.
- Size:  $\varnothing$  85 mm (3.35") or  $\varnothing$  133 mm (5.24")
- Function: NC, NO or Air/Air
- Valve control options

